

VHF/UHF Transistors

- We declare that the material of product compliance with RoHS requirements.

Ordering Information

| Device | Marking | Shipping |
|-------------|---------|-----------------|
| LMBTH10LT1G | 3EM | 3000/Tape&Reel |
| LMBTH10LT3G | 3EM | 10000/Tape&Reel |

MAXIMUM RATINGS

| Rating | Symbol | Value | Unit |
|---------------------------|-----------|-------|------|
| Collector–Emitter Voltage | V_{CEO} | 25 | Vdc |
| Collector–Base Voltage | V_{CBO} | 30 | Vdc |
| Emitter–Base Voltage | V_{EBO} | 3.0 | Vdc |

THERMAL CHARACTERISTICS

| Characteristic | Symbol | Max | Unit |
|-----------------------------------------------------------------------------|-----------------|-------------|---------------------------|
| Total Device Dissipation FR– 5 Board, (1) $T_A = 25^\circ\text{C}$ | P_D | 225 | mW |
| Derate above 25°C | | 1.8 | mW/ $^\circ\text{C}$ |
| Thermal Resistance, Junction to Ambient | $R_{\theta JA}$ | 556 | $^\circ\text{C}/\text{W}$ |
| Total Device Dissipation Alumina Substrate, (2) $T_A = 25^\circ\text{C}$ | P_D | 300 | mW |
| Derate above 25°C | | 2.4 | mW/ $^\circ\text{C}$ |
| Thermal Resistance, Junction to Ambient | $R_{\theta JA}$ | 417 | $^\circ\text{C}/\text{W}$ |
| Junction and Storage Temperature | T_J, T_{stg} | –55 to +150 | $^\circ\text{C}$ |

DEVICE MARKING

| |
|-------------------|
| LMBTH10LT1G = 3EM |
|-------------------|

ELECTRICAL CHARACTERISTICS ($T_A = 25^\circ\text{C}$ unless otherwise noted.)

| Characteristic | Symbol | Min | Typ | Max | Unit |
|----------------|--------|-----|-----|-----|------|
|----------------|--------|-----|-----|-----|------|

OFF CHARACTERISTICS

| | | | | | |
|------------------------------------------------------------------------------|---------------|-----|---|-----|------|
| Collector–Emitter Breakdown Voltage ($I_C = 1.0 \text{ mAdc}, I_E = 0$) | $V_{(BR)CEO}$ | 25 | — | — | Vdc |
| Collector–Base Breakdown Voltage ($I_C = 100 \mu\text{Adc}, I_E = 0$) | $V_{(BR)CBO}$ | 30 | — | — | Vdc |
| Emitter–Base Breakdown Voltage ($I_E = 10 \mu\text{Adc}, I_C = 0$) | $V_{(BR)EBO}$ | 3.0 | — | — | Vdc |
| Collector Cutoff Current ($V_{CB} = 25\text{Vdc}, I_E = 0$) | I_{CBO} | — | — | 100 | nAdc |
| Collector Cutoff Current ($V_{CB} = 30\text{Vdc}, I_E = 0$) | I_{CBO} | — | — | 100 | uAdc |
| Emitter Cutoff Current ($V_{EB} = 2.0\text{Vdc}, I_C = 0$) | I_{EBO} | — | — | 100 | nAdc |
| Emitter Cutoff Current ($V_{EB} = 3.0\text{Vdc}, I_C = 0$) | I_{EBO} | — | — | 10 | uAdc |

1. FR–5 = 1.0 x 0.75 x 0.062 in.

2. Alumina = 0.4 x 0.3 x 0.024 in. 99.5% alumina.

LMBTH10LT1G

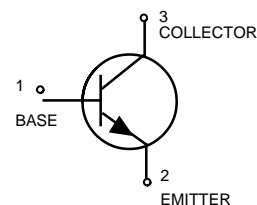
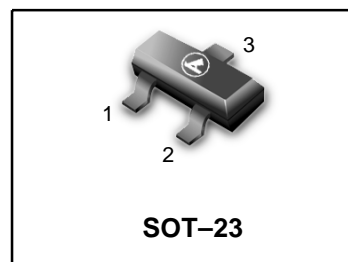

LMBTH10LT1G
ELECTRICAL CHARACTERISTICS ($T_A = 25^\circ\text{C}$ unless otherwise noted) (Continued)

| Characteristic | Symbol | Min | Typ | Max | Unit |
|----------------|--------|-----|-----|-----|------|
|----------------|--------|-----|-----|-----|------|

ON CHARACTERISTICS

| | | | | | |
|-------------------------------------------------------------------------------------------|---------------|----|---|------|-----|
| DC Current Gain ($I_C = 4.0\text{ mA}$, $V_{CE} = 10\text{ Vdc}$) | h_{FE} | 60 | — | — | — |
| Collector–Emitter Saturation Voltage ($I_C = 4.0\text{ mA}$, $I_B = 0.4\text{ mA}$) | $V_{CE(sat)}$ | — | — | 0.5 | Vdc |
| Base–Emitter On Voltage ($I_C = 4.0\text{ mA}$, $V_{CE} = 10\text{ Vdc}$) | V_{BE} | — | — | 0.95 | Vdc |

SMALL–SIGNAL CHARACTERISTICS

| | | | | | |
|---------------------------------------------------------------------------------------------------------------|------------|-----|---|------|-----|
| Current Gain–Bandwidth Product ($V_{CE} = 10\text{ Vdc}$, $I_C = 4.0\text{ mA}$, $f = 100\text{ MHz}$) | f_T | 650 | — | — | MHz |
| Collector –Base Capacitance ($V_{CB} = 10\text{ Vdc}$, $I_E = 0$, $f = 1.0\text{ MHz}$) | C_{cb} | — | — | 0.7 | pF |
| Collector –Base Feedback Capacitance ($V_{CB} = 10\text{ Vdc}$, $I_E = 0$, $f = 1.0\text{ MHz}$) | C_{fb} | — | — | 0.65 | pF |
| Collector Base Time Constant ($I_C = 4.0\text{ mA}$, $V_{CB} = 10\text{ Vdc}$, $f = 31.8\text{ MHz}$) | $r_b' C_C$ | — | — | 9.0 | ps |

LMBTH10LT1G

TYPICAL CHARACTERISTICS

COMMON-BASE y PARAMETERS versus FREQUENCY

($V_{CB} = 10 \text{ Vdc}$, $I_C = 4.0 \text{ mA dc}$, $T_A = 25^\circ\text{C}$)

y_{ib} , INPUT ADMITTANCE

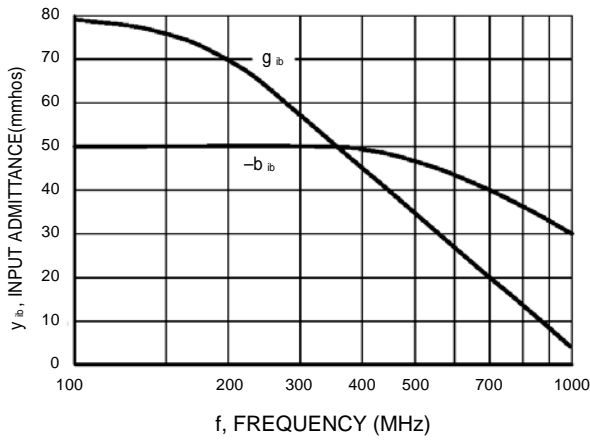

Figure 1. Rectangular Form

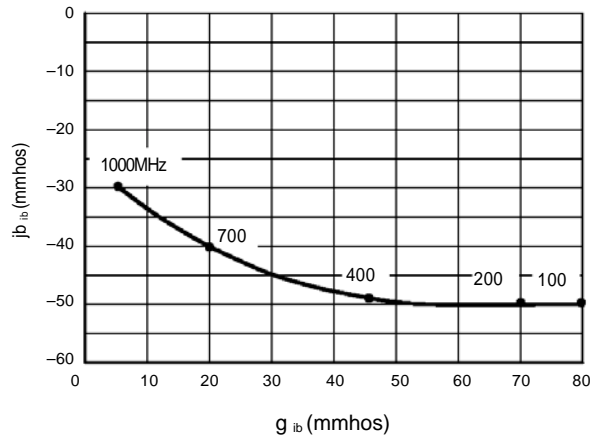

Figure 2. Polar Form

y_{fb} , FORWARD TRANSFER ADMITTANCE

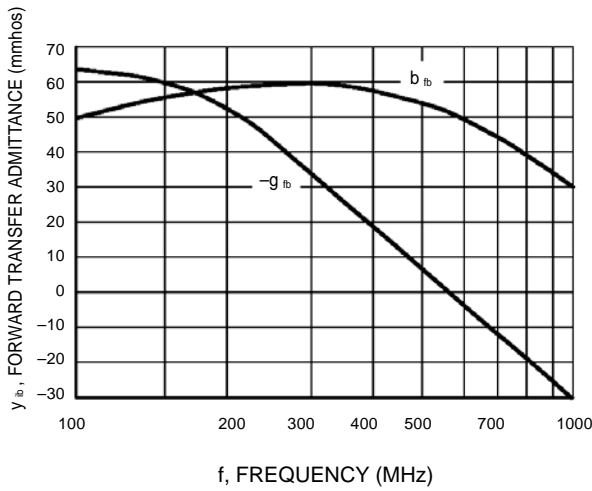

Figure 3. Rectangular Form

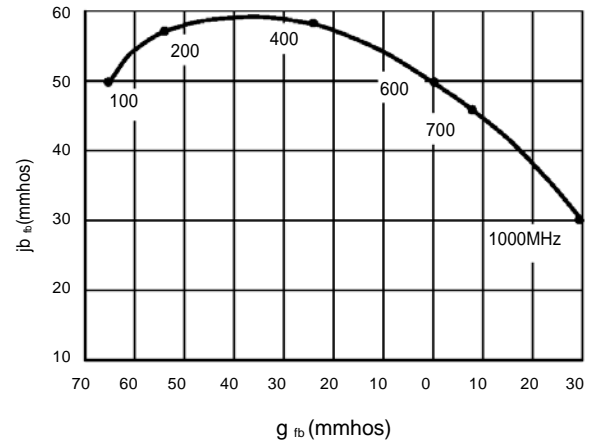

Figure 4. Polar Form

LMBTH10LT1G

TYPICAL CHARACTERISTICS

COMMON-BASE y PARAMETERS versus FREQUENCY

($V_{CB} = 10 \text{ Vdc}$, $I_C = 4.0 \text{ mAdc}$, $T_A = 25^\circ\text{C}$)

y_{rb} , REVERSE TRANSFER ADMITTANCE

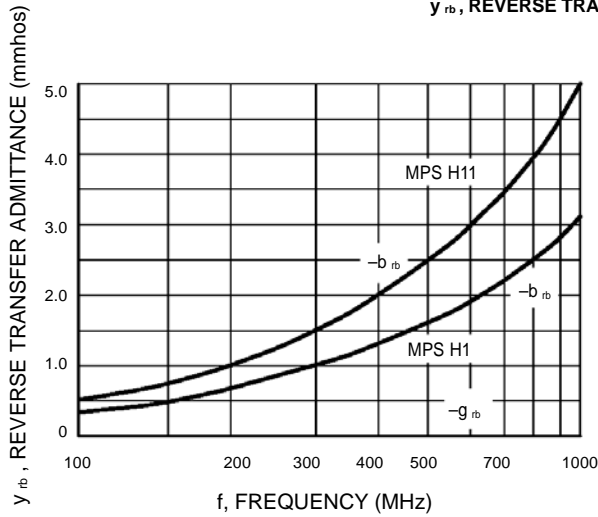

Figure 5. Rectangular Form

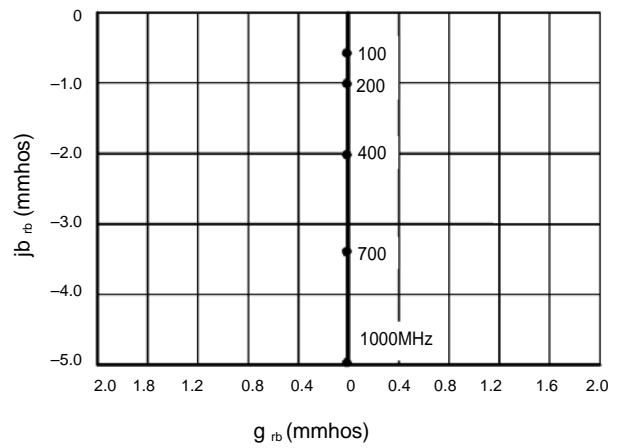

Figure 6. Polar Form

y_{ob} , OUTPUT ADMITTANCE

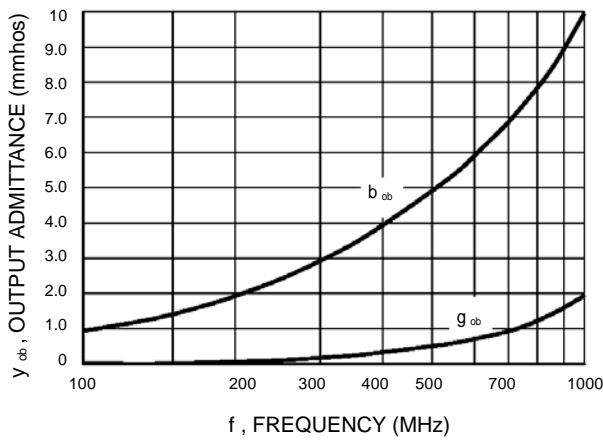

Figure 7. Rectangular Form

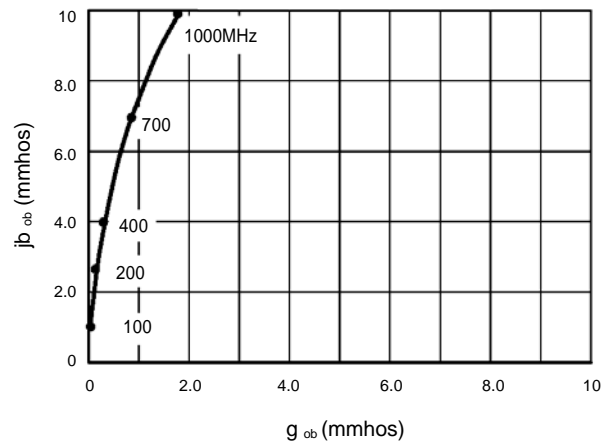
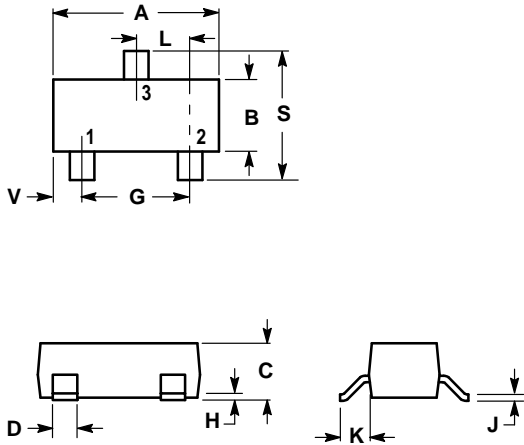

Figure 8. Polar Form

LMBTH10LT1G

SOT-23



NOTES:

1. DIMENSIONING AND TOLERANCING PER ANSI Y14.5M, 1982.
2. CONTROLLING DIMENSION: INCH.

| DIM | INCHES | | MILLIMETERS | |
|-----|--------|--------|-------------|-------|
| | MIN | MAX | MIN | MAX |
| A | 0.1102 | 0.1197 | 2.80 | 3.04 |
| B | 0.0472 | 0.0551 | 1.20 | 1.40 |
| C | 0.0350 | 0.0440 | 0.89 | 1.11 |
| D | 0.0150 | 0.0200 | 0.37 | 0.50 |
| G | 0.0701 | 0.0807 | 1.78 | 2.04 |
| H | 0.0005 | 0.0040 | 0.013 | 0.100 |
| J | 0.0034 | 0.0070 | 0.085 | 0.177 |
| K | 0.0140 | 0.0285 | 0.35 | 0.69 |
| L | 0.0350 | 0.0401 | 0.89 | 1.02 |
| S | 0.0830 | 0.1039 | 2.10 | 2.64 |
| V | 0.0177 | 0.0236 | 0.45 | 0.60 |

- PIN 1. BASE
 2. EMITTER
 3. COLLECTOR

